



BacT/ALERT[®] 3D

Your lab's best friend

Being first, being smarter

A smart and modular design makes BacT/ALERT 3D the most compact automated microbial detection system around.

Introduced in 1990, over 6,000 BacT/ALERT 3D systems have been installed worldwide to perform blood culture, body fluid culture and/or mycobacterial testing.



All BacT/ALERT 3D systems share the same time-proven technology and easy-to-use design, making them the most reliable partner for your laboratory.

The same high-performance technology ensures safety and time-savings



The patented colorimetric detection system, based on sophisticated algorithms are designed to detect microorganisms early, even with **delayed entry**.

Each cell is equipped with a patented cell flag, ensuring instant bottle recognition and **automated quality control**.

Continuous monitoring gives **immediate notification of results** with instant visual and audible alerts, including a remote alarm capability. User-directed bottle loading greatly facilitates the workflow.

Specific colorimetric technology with visual positive signal.



The same - Touch, Wand, Load - procedure simplifies your daily workload



Touch



Wand











Load

The operator uses the touch-screen for text-free control over the system while barcode-scanning the bottle ID before loading. The added bonus of this simplified handling procedure is that training is kept to a minimum.

The same flexible system design adapts to your laboratory requirements

The BacT/ALERT 3D **expandable** design enables you to add additional testing capacity as you need it. Its stackable modules can be arranged to save space and accommodate any laboratory layout. Occupying one third of the space of other systems, BacT/ALERT 3D is the **most compact microbial detection system available**. Each individual module can be configured to perform either blood culture, body fluid and/or mycobacteria testing.

Annual bottle volume*	Module
7,000	
14,000	
21,000	
28,000	
35,000	
44,000	
56,000	
70,000	
84,000	

BacT/ALERT 3D can meet all your volume requirements - simply choose the number of modules required based on your laboratory testing volume.

* Five day protocol.



➤ Controller Module

This module enables up to 6 Incubation Modules to be operated from one set of electronics and integrated computer hardware.

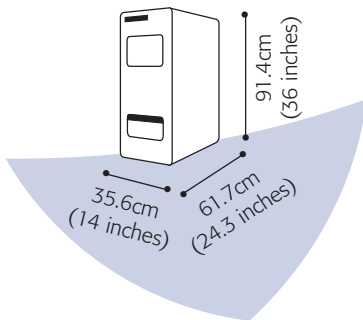

Weight : 58Kg (128lbs)

➤ Incubation Module

Four incubation drawers of 60 cells giving a total capacity of 240 cells. Each drawer has an independent shaking mechanism, enabling static or shaken cultures within the same system.

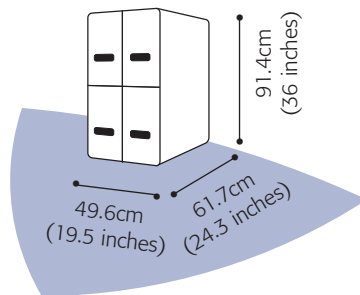

Unloaded Weight : 119Kg (262lbs)
Loaded Weight : 140Kg (307lbs)

➤ Combination Module

It combines all the BacT/ALERT 3D capabilities in a surprisingly compact format : a control and Incubation Module in a single instrument to perform blood culture, body fluid and/or mycobacteria testing. Each module has a total incubation capacity of 120 cells (2 drawers) but can also connect to up to 3 Incubation Modules.

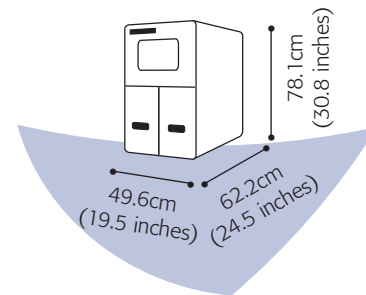

Unloaded Weight : 90.7Kg (200lbs)
Loaded Weight : 98.2Kg (216.5lbs)

Specifications

Electrical Power

Services Requirements

- 100/120 Volts (50-60 HZ)
- 220/240 Volts (50-60 HZ)

Power Consumed in Watts

- @115 V.A.C. 72 Watts typical
- @230 V.A.C. 72 Watts typical

Heat Dissipated

- 245 Btu/Hr. 2840 maximum

Sound Emission

- 46.4 dB

Environmental Requirements

- Operating Temperature Range 10°C to 30°C (50°F-86°F)
- Operating Humidity Range 10% to 90% relative humidity, non-condensing

Specifications

Capacity

- 240 cells (60 cells/drawer)

Electrical Power Services Requirements

- 100/120 Volts (50-60 HZ)
- 220/240 Volts (50-60 HZ)

Power Consumed in Watts

- @115 V.A.C. 256 Watts (idle), 640 Watts typical
- @230 V.A.C. 265 Watts (idle), 640 Watts typical

Heat Dissipated

- 904 Btu/Hr. 2840 maximum

Sound Emission

- 54.7 dB

Environmental Requirements

- Operating Temperature Range 10°C to 30°C (50°F-86°F)
- Operating Humidity Range 10% to 90% relative humidity, non-condensing

Specifications

Capacity

- 120 cells (60 cells/drawer)

Electrical Power

Services Requirements

- 100/120 Volts (50-60 HZ)
- 220/240 Volts (50-60 HZ)

Power Consumed in Watts

- @115 V.A.C. 256 Watts (idle), 640 Watts typical
- @230 V.A.C. 265 Watts (idle), 640 Watts typical

Heat Dissipated

- 904 Btu/Hr. 2840 maximum

Sound Emission

- 55.5 dB

Environmental Requirements

- Operating Temperature Range 10°C to 30°C (50°F-86°F)
- Operating Humidity Range 10% to 90% relative humidity, non-condensing

The same user-friendly approach for data management ensures optimum flexibility

BacT/ALERT 3D offers you the data management option which best suits your unique laboratory organization.

Each option has virtually the same graphical, text-free, touch-screen user interface.



Select™

The standard solution for routine microbial testing where sophisticated data management and Laboratory Information System (LIS) connectivity are not needed.

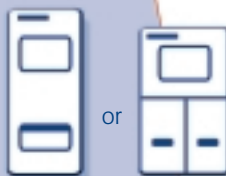

SelectLink™

The ideal solution for routine microbial testing where a bi-directional LIS interface is required to exchange patient data and results.

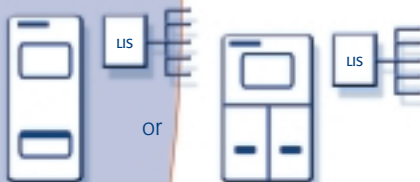

Signature™

The high-performance solution when extensive data management capabilities are required. This is possible through the LIS interface and the OBSERVA™ software package.

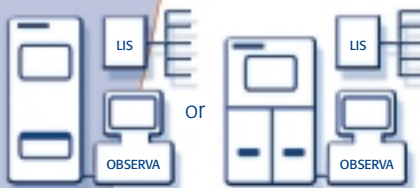

bioMérieux sa
69280 Marcy l'Etoile
France
Tel. : (33) 04 78 87 20 00
Fax. : (33) 04 78 87 20 90

www.biomerieux.com

Manufactured by :
bioMérieux Inc.
100 Rodolphe Street,
Durham, NC 27712
USA
Tel. : 00 1 919 620 2000
Fax. : 00 1 919 620 2211

bioMérieux Inc. is a wholly-owned subsidiary of bioMérieux sa.



B I O M É R I E U X